

Fibre Cement

Profile
Detail

Duragroove™
Sheet Edge Positioning

Date Jan 2013
Scale 1:2
Detail No. ADGV_003

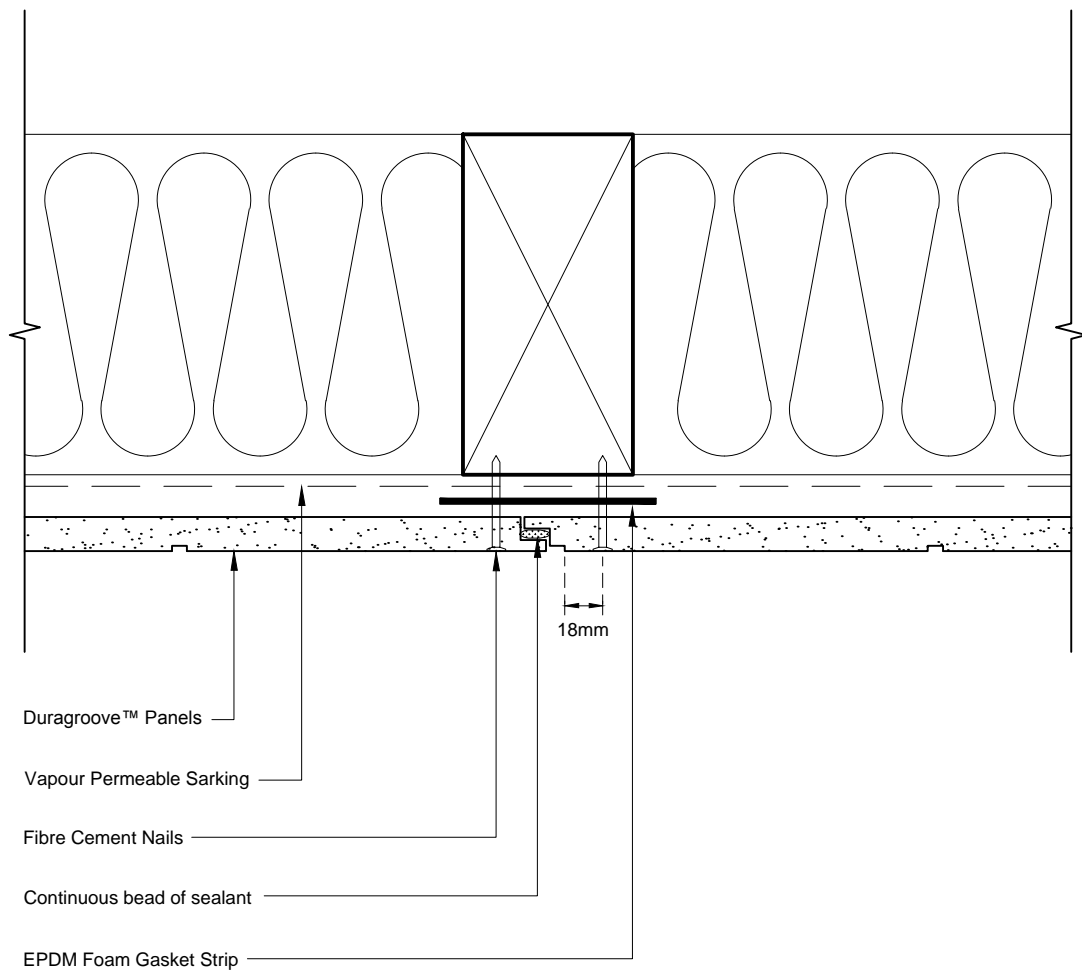

Fibre Cement

Profile
Detail

Duragroove™
F/C Nail Fixing-Timber Frame

Date Jan 2013
Scale 1:2
Detail No. ADGV_004

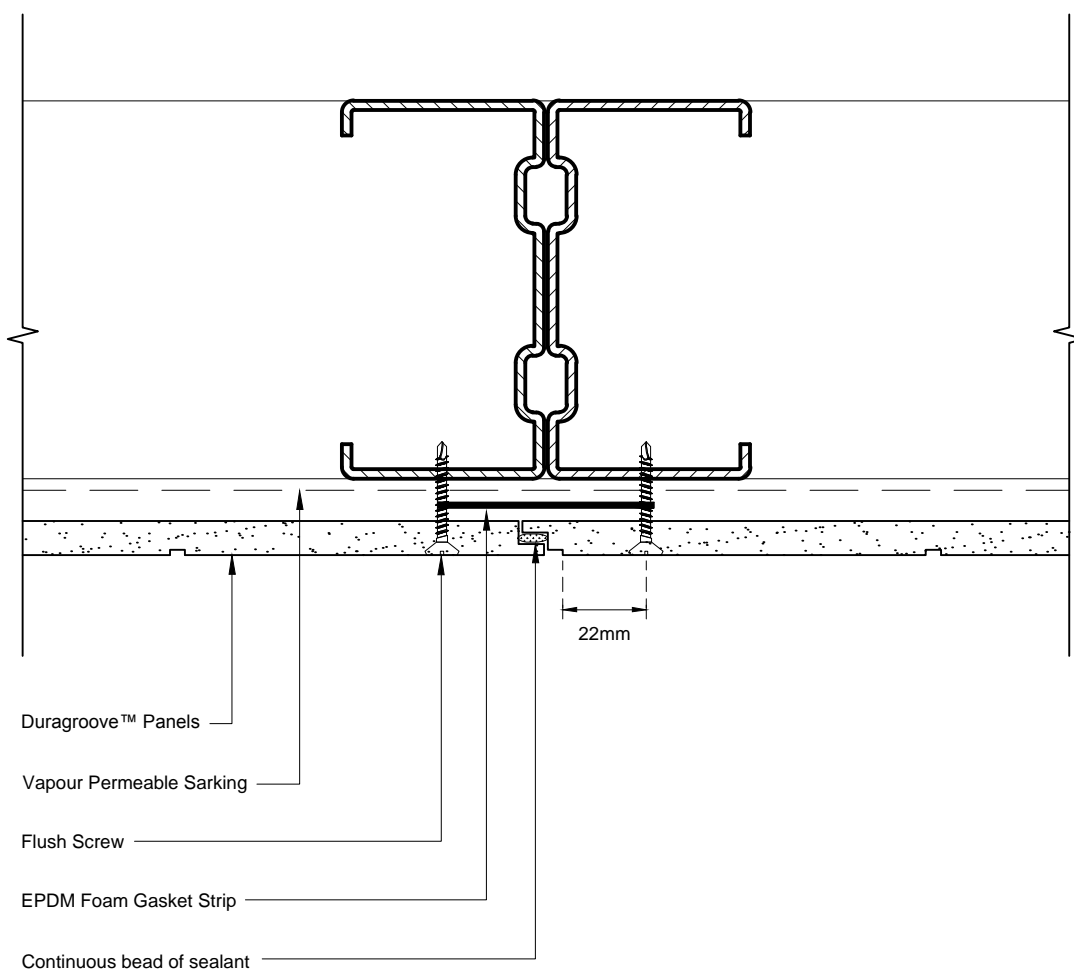

Fibre Cement

Profile
Detail

Duragroove™
Countersunk Screw-Lightweight Steel Frame

Date Jan 2013

Scale 1:2

Detail No. ADGV_005

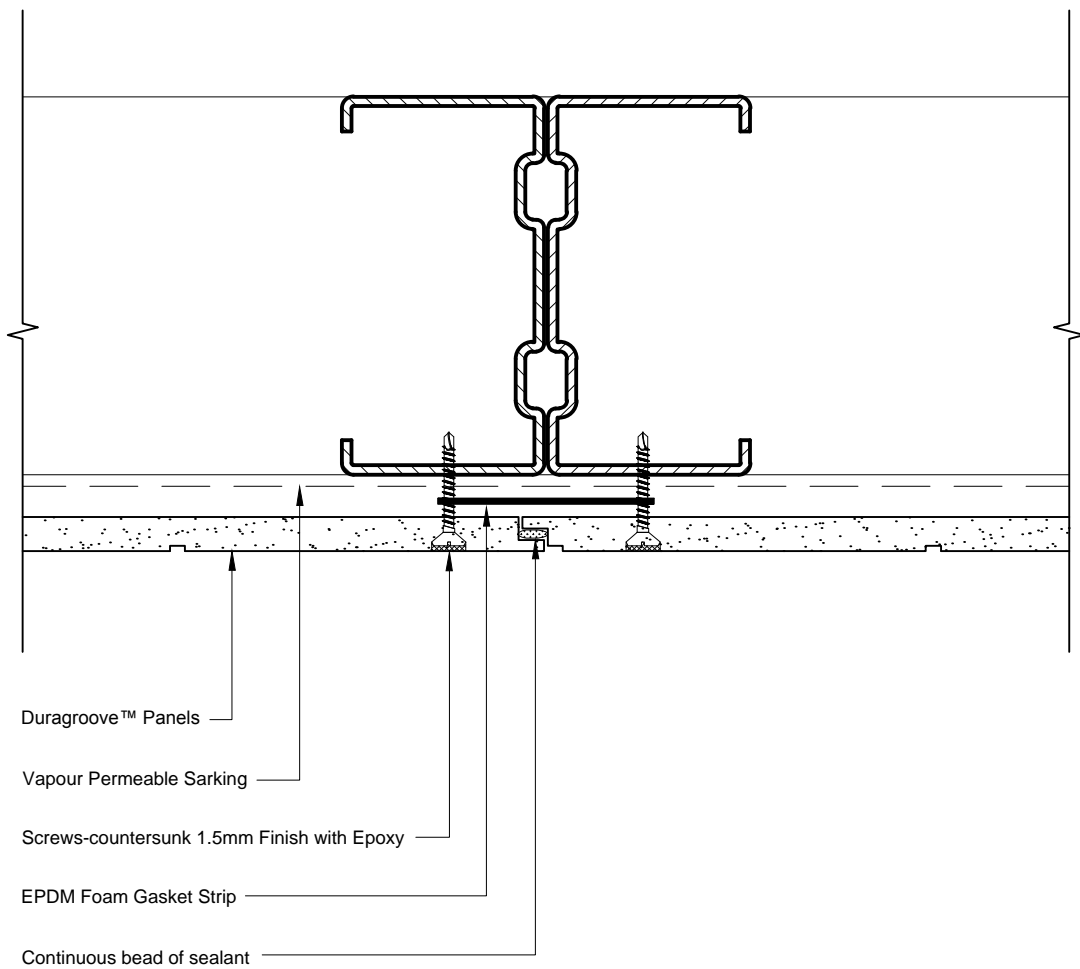

Fibre Cement

Profile
Detail

Duragroove™
Flush Screw-Lightweight Steel Frame

Date Jan 2013
Scale 1:2
Detail No. ADGV_006

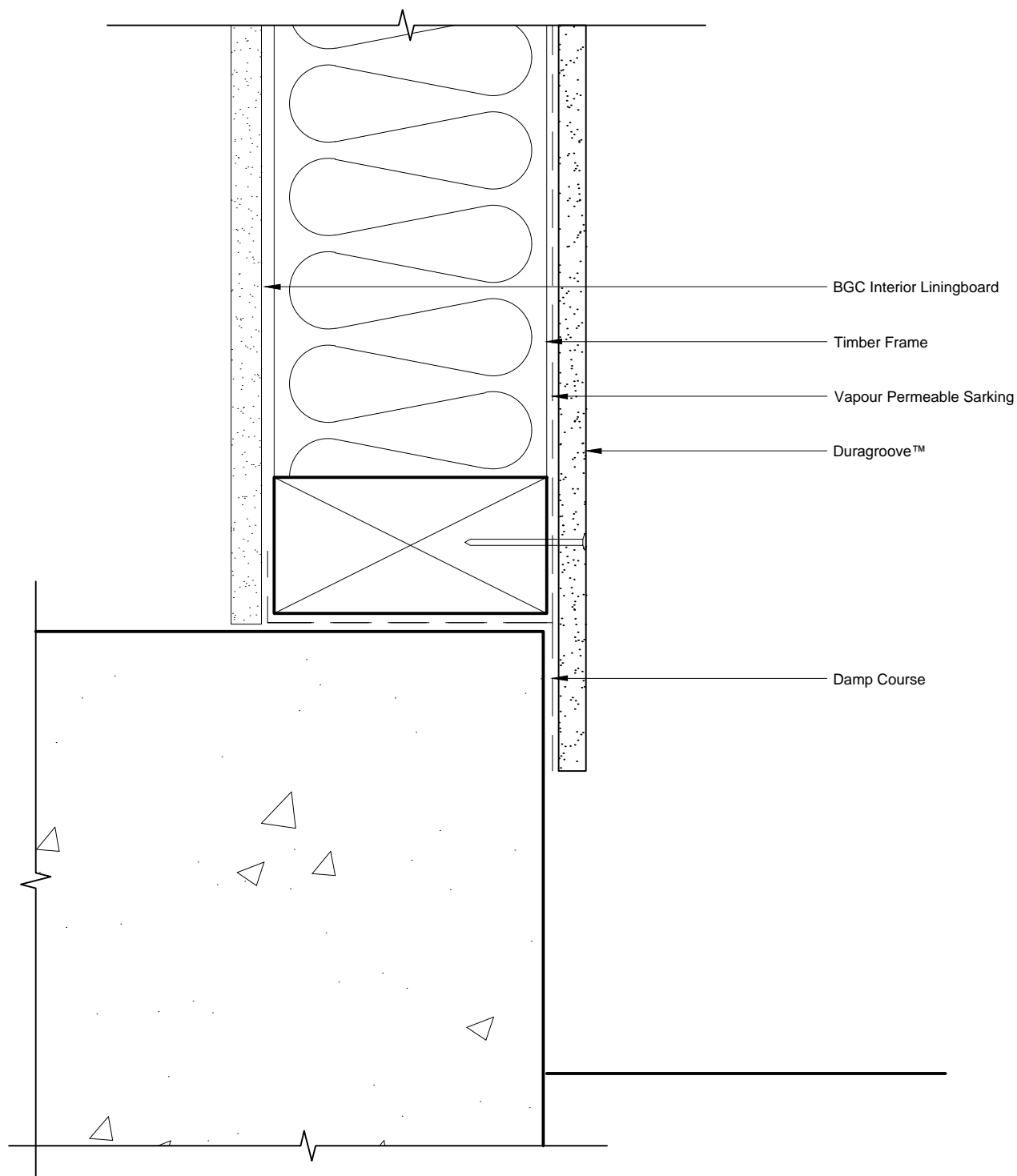

Fibre Cement

Profile
Detail

Duragroove™
Slab Edge/Eave Junction

Date Jan 2013

Scale 1:2

Detail No. ADGV_010

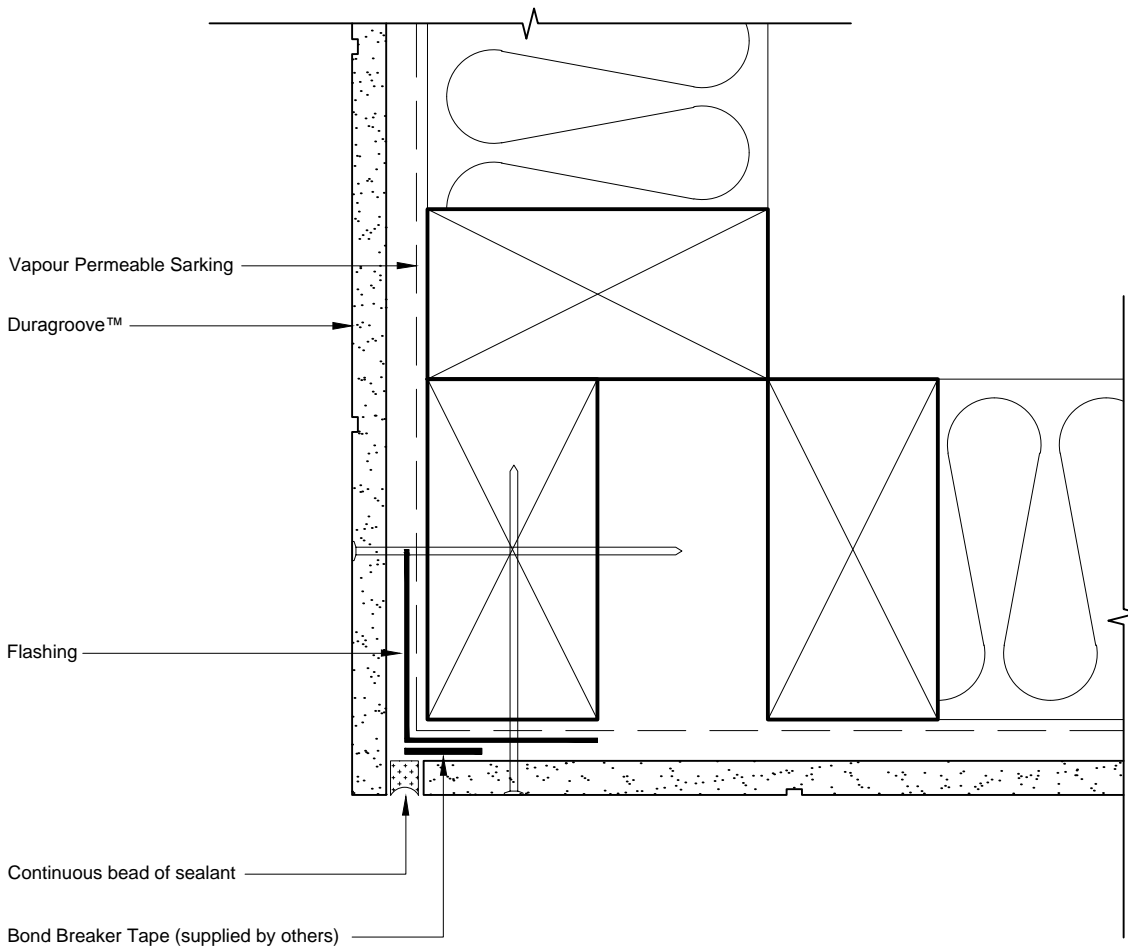

Fibre Cement

Profile
Detail

Duragroove™
External Corner-Sealant Option

Date Jan 2013
Scale 1:2
Detail No. ADGV_011

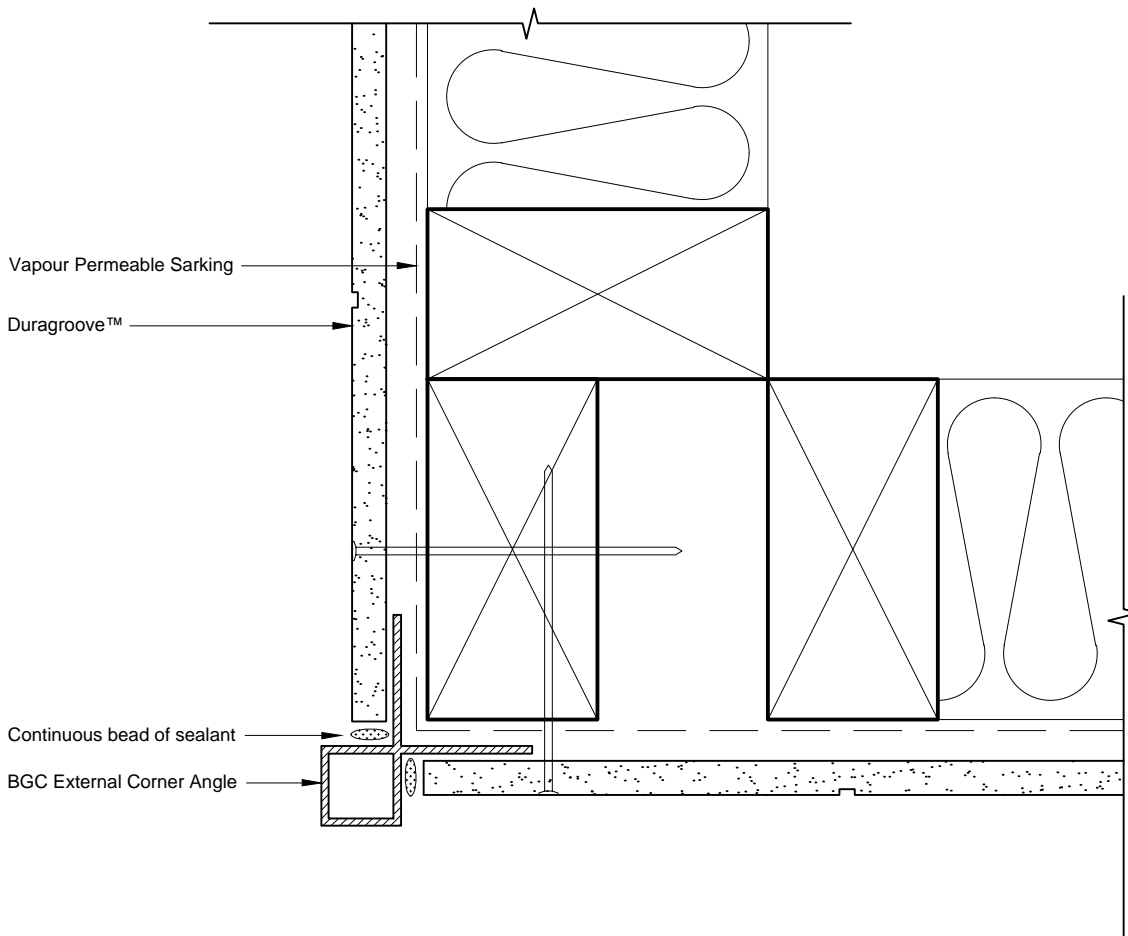

Fibre Cement

Profile
Detail

Duragroove™
External Corner-Steel

Date Jan 2013
Scale 1:2
Detail No. ADGV_012

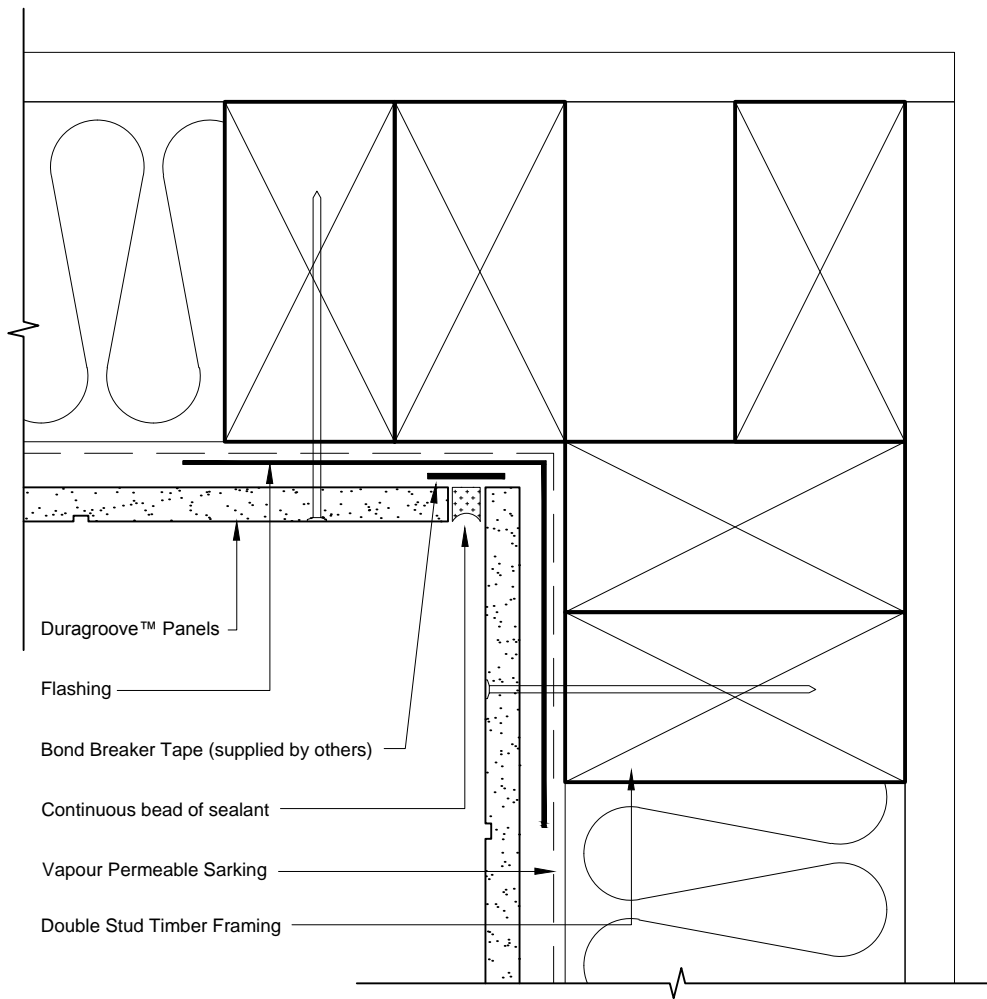

Fibre Cement

Profile
Detail

Duragroove™
Internal Corner-Sealant Option

Date Jan 2013

Scale 1:2

Detail No. ADGV_013

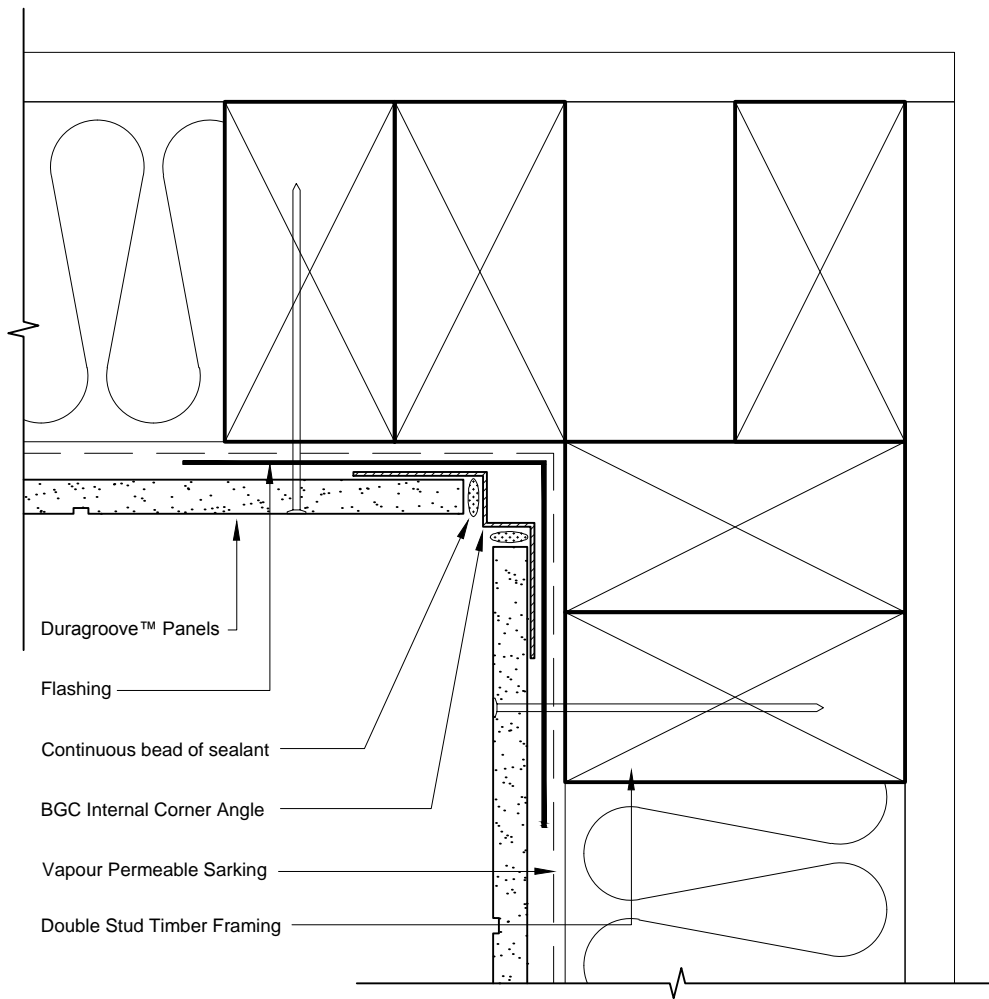

Duragroove™ Panels

Flashing

Continuous bead of sealant

BGC Internal Corner Angle

Vapour Permeable Sarking

Double Stud Timber Framing

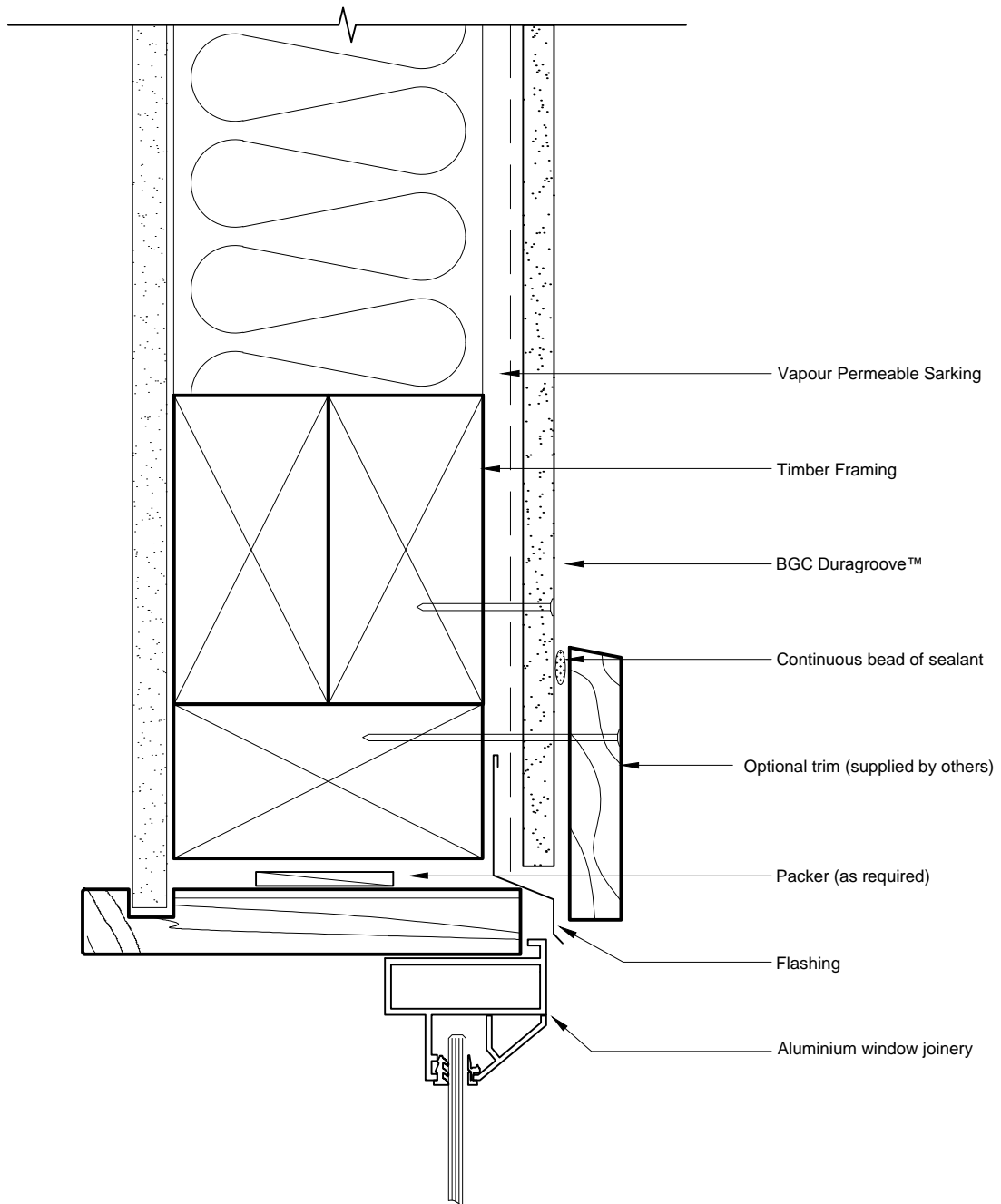

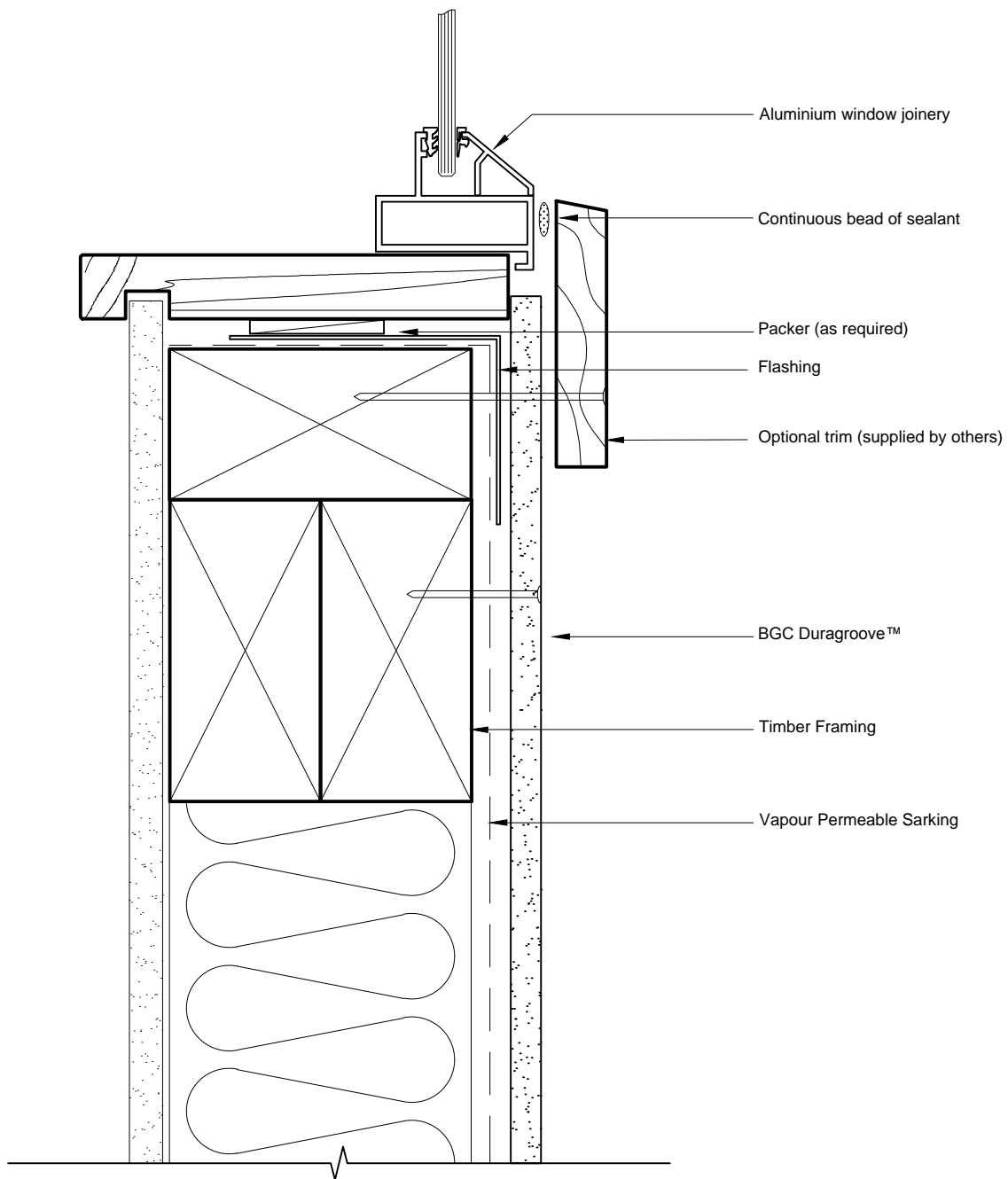

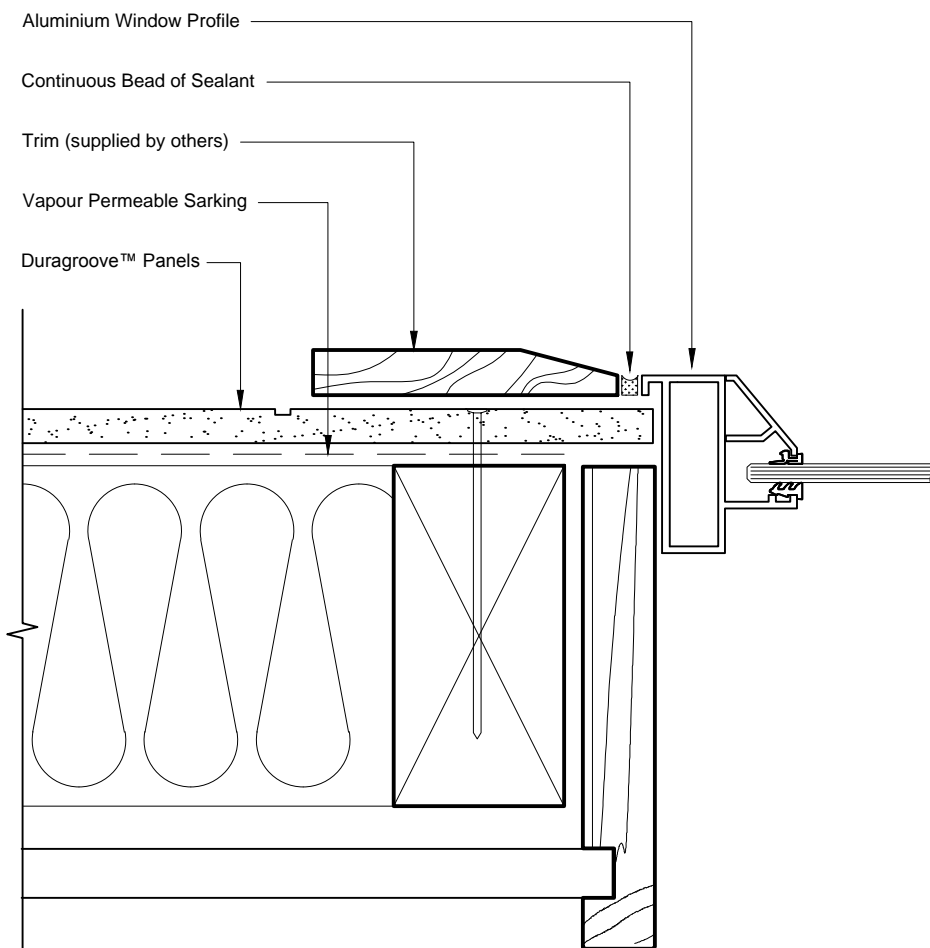

Fibre Cement

Profile
Detail

Duragroove™
Window Jamb

Date Jan 2013

Scale 1:2

Detail No. ADGV_017

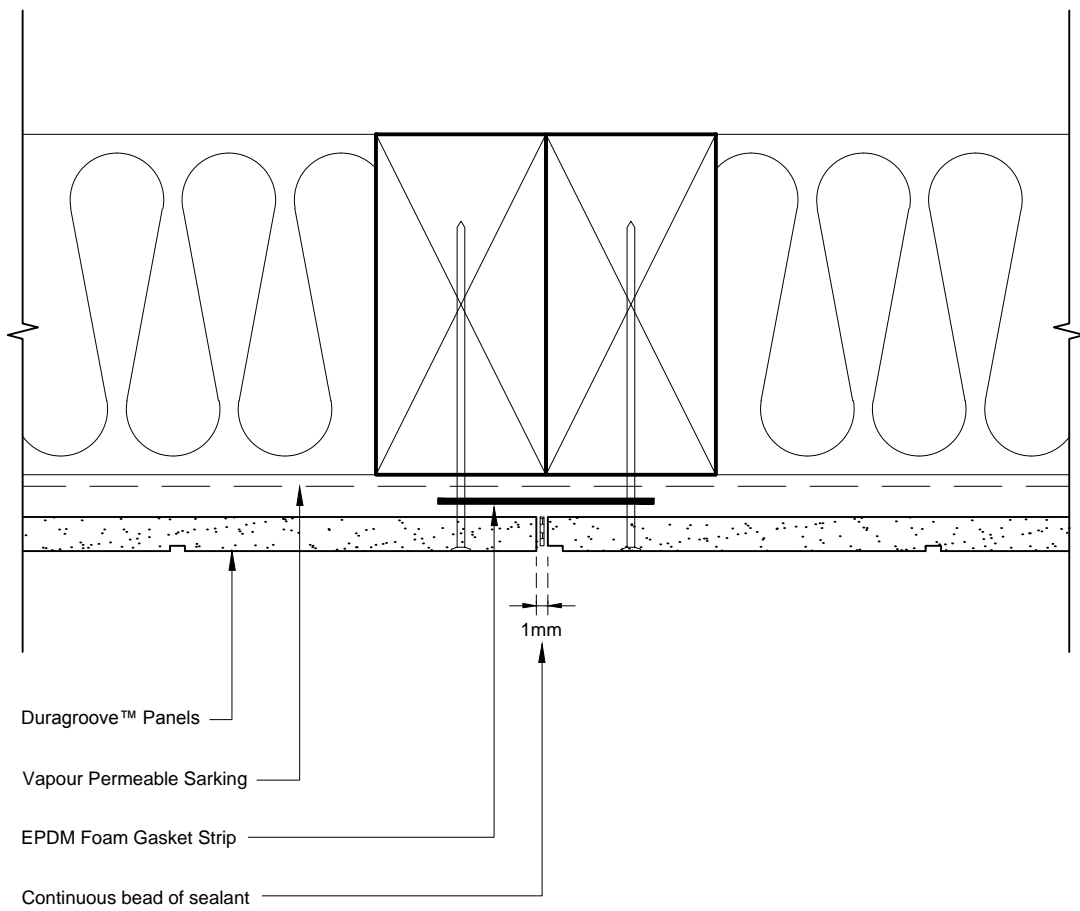

Fibre Cement

Profile
Detail

Duragroove™
Vertical Butt Joint

Date Jan 2013

Scale 1:2

Detail No. ADGV_018

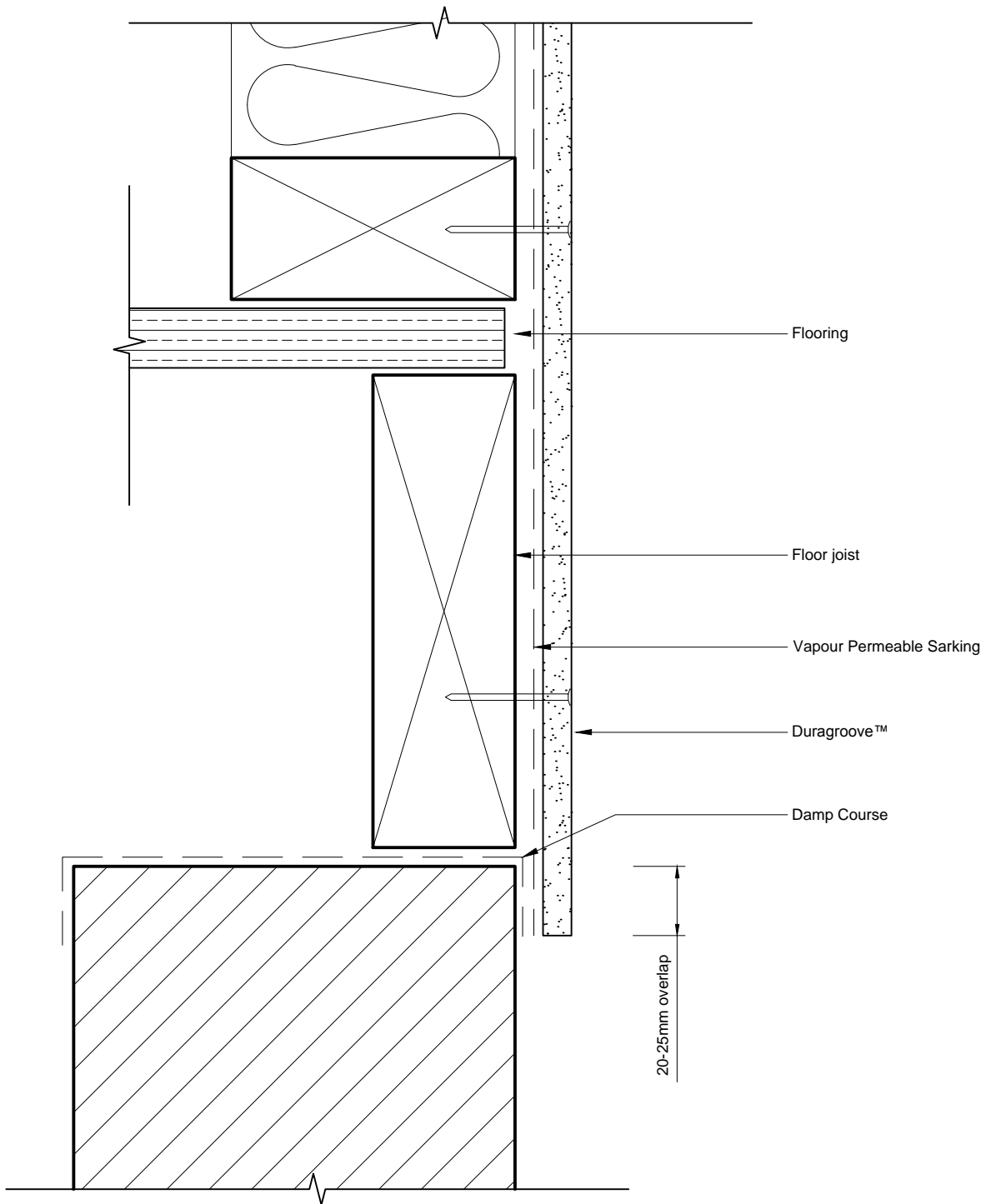

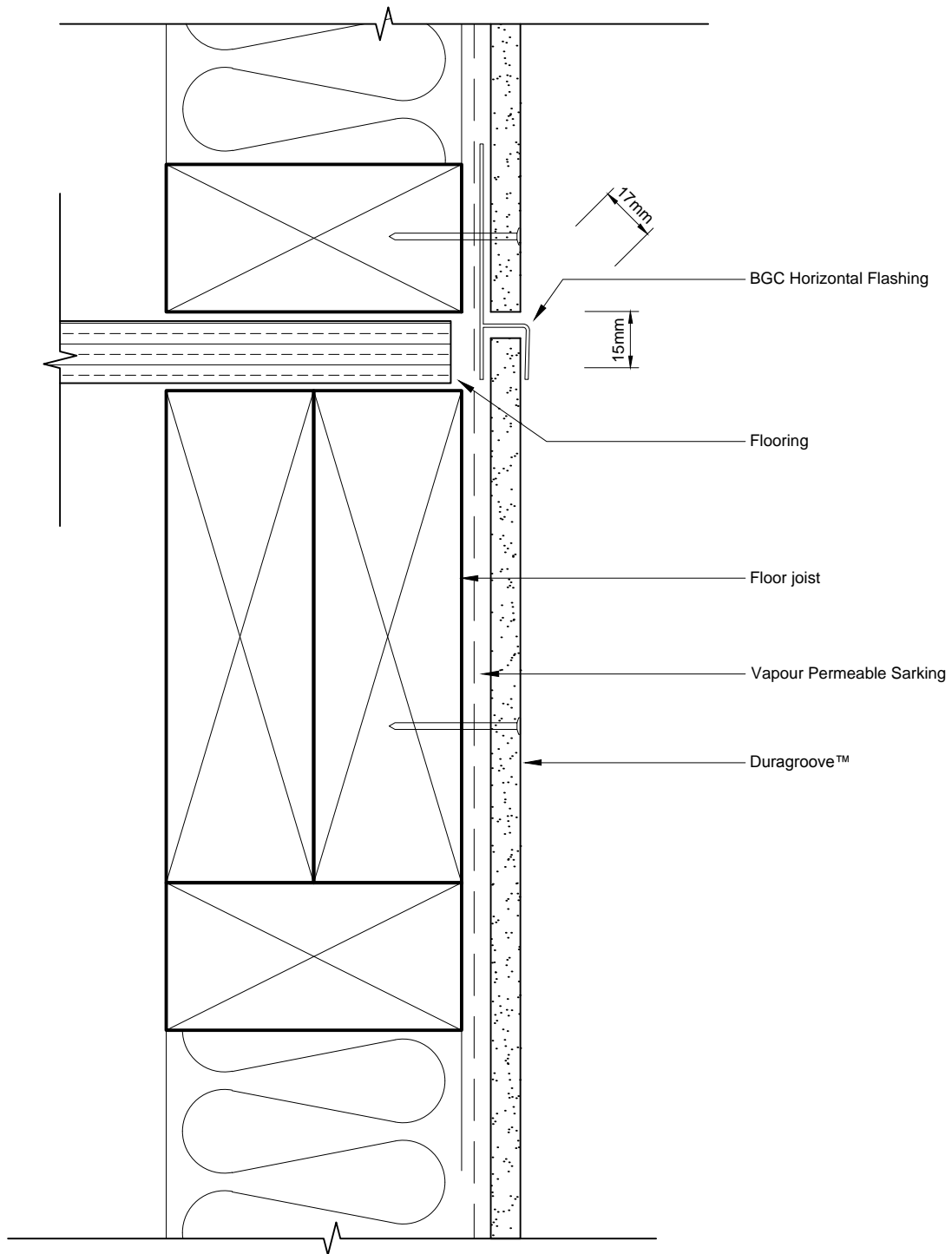

Fibre Cement

Profile
Detail

Duragroove™
Upper Floor Junction

Date Jan 2013

Scale 1:2

Detail No. ADGV_020

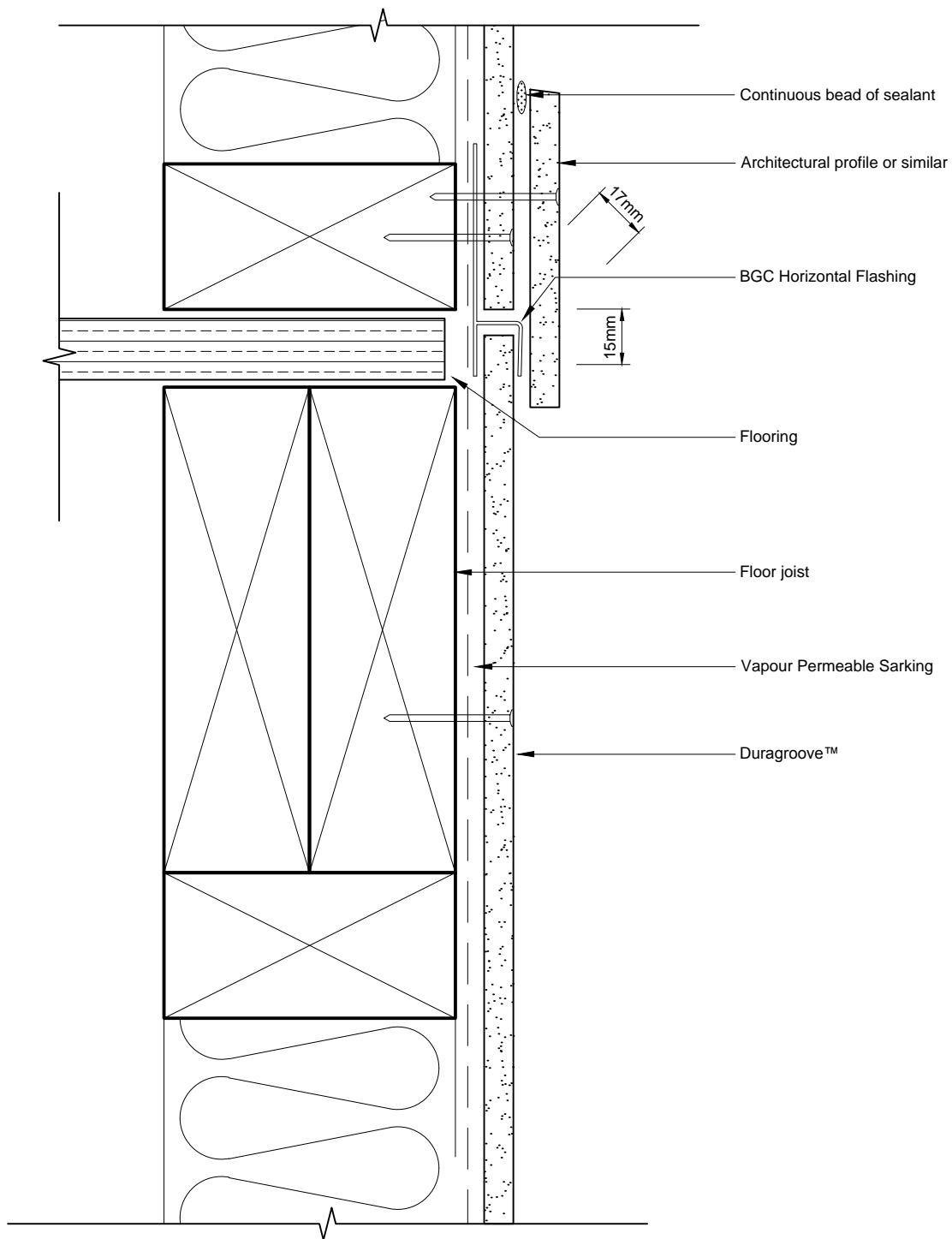

Fibre Cement

Profile
Detail

Duragroove™

Upper Floor Junction-
Option 2

Date Jan 2013

Scale 1:2

Detail No. ADGV_021

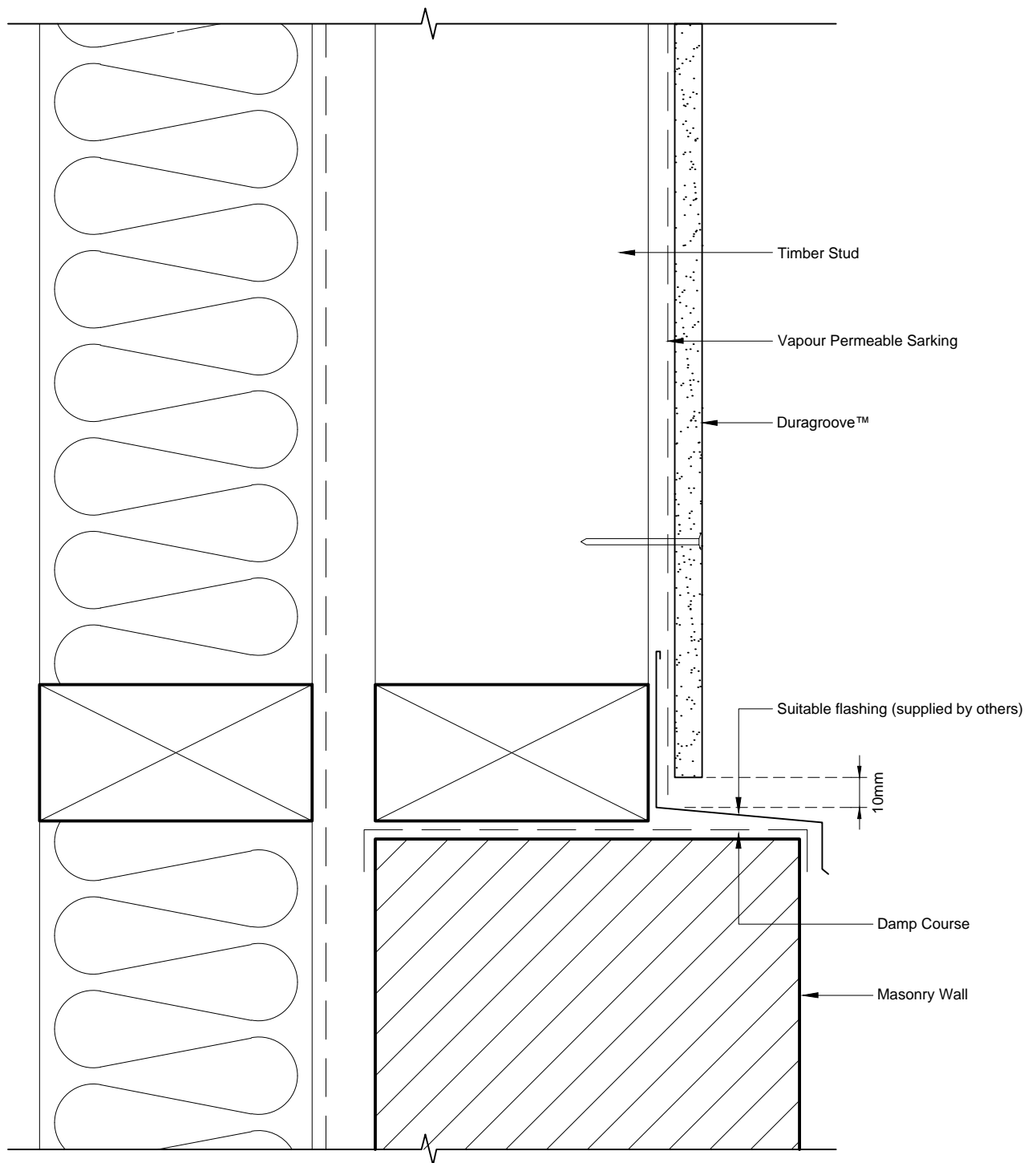

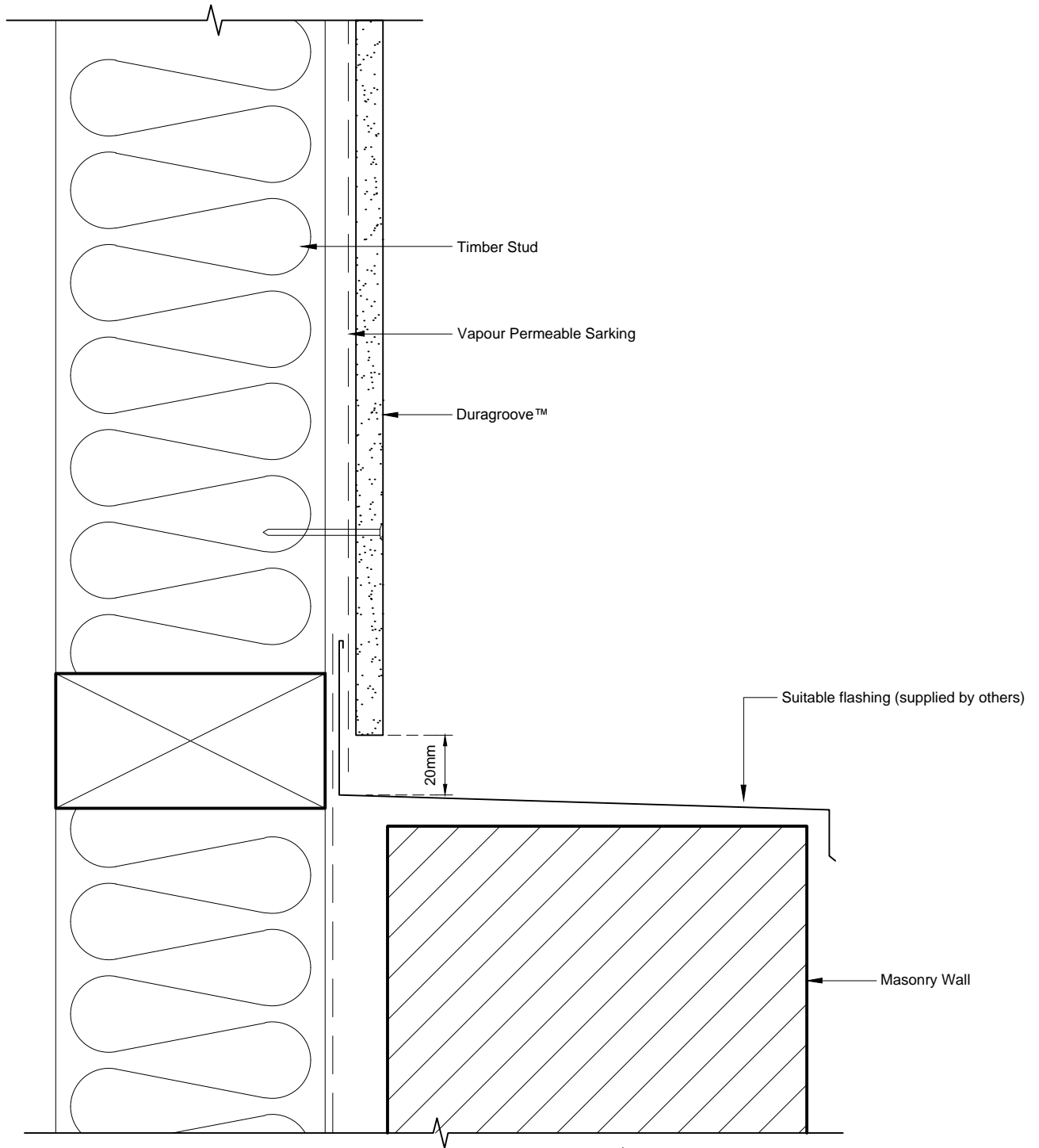

Fibre Cement

Profile
Detail

Duragroove™
Horizontal Junction-2

Date Jan 2013

Scale 1:2

Detail No. ADGV_023

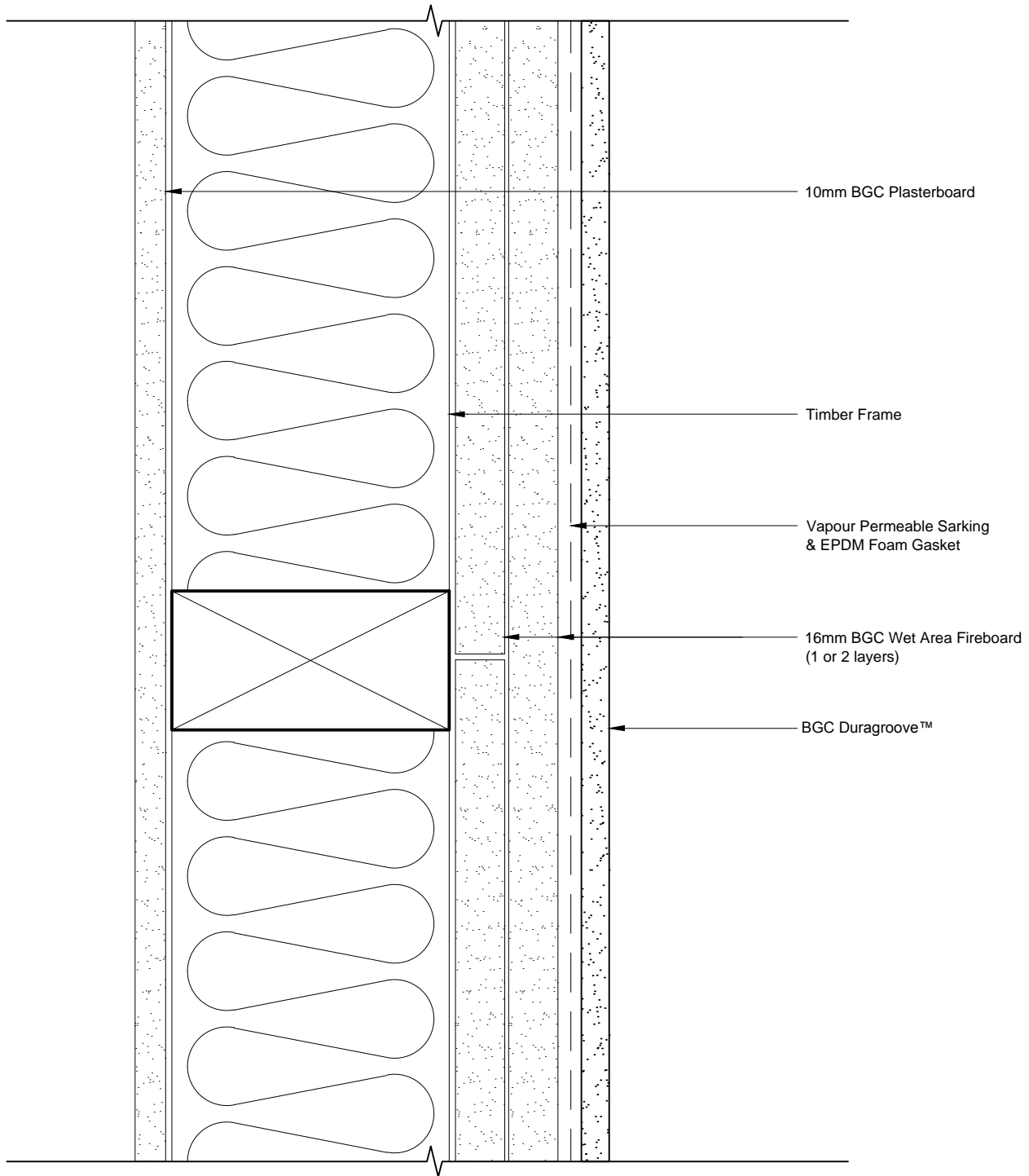

Fibre Cement

Profile
Detail

Duragroove™
Boundary Wall System

Date Jan 2013

Scale 1:2

Detail No. ADGV_024